

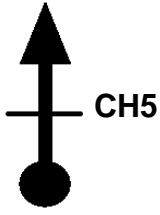



10èmes Routes du Vexin Classic

N° Partiel Total	Indication	Commentaire
1 0,00		
2 0,13		RAZ
3 0,68		Sarnois
4 0,41 1,09		Grandvilliers
5 0,42 1,51		D315 A29
6 0,20 1,71		et RDA
7 0,73 2,44		RSRP
8 1,05 3,49		Grandvilliers D124

N° Partiel Total	Indication	Commentaire
9 1,87 5,36		Brombos
10 0,45 5,81		et RDA
11 1,21 7,02		Brombos D96
12	Suivre carte page suivante	

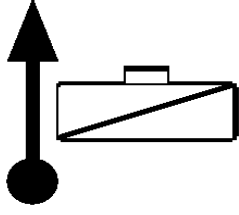
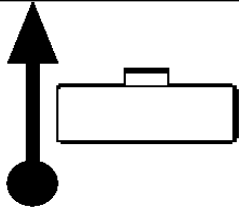
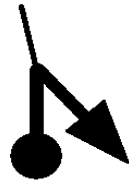
N° Partiel Total	Indication	Commentaire
---------------------	------------	-------------

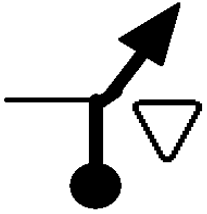
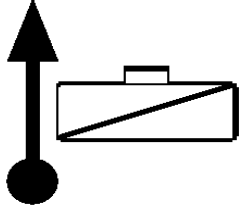
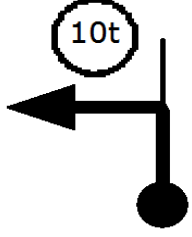
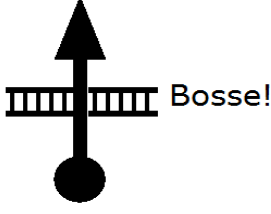
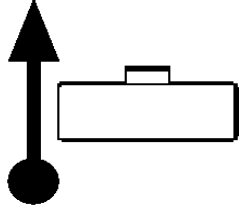
N° Partiel Total	Indication	Commentaire
---------------------	------------	-------------

12

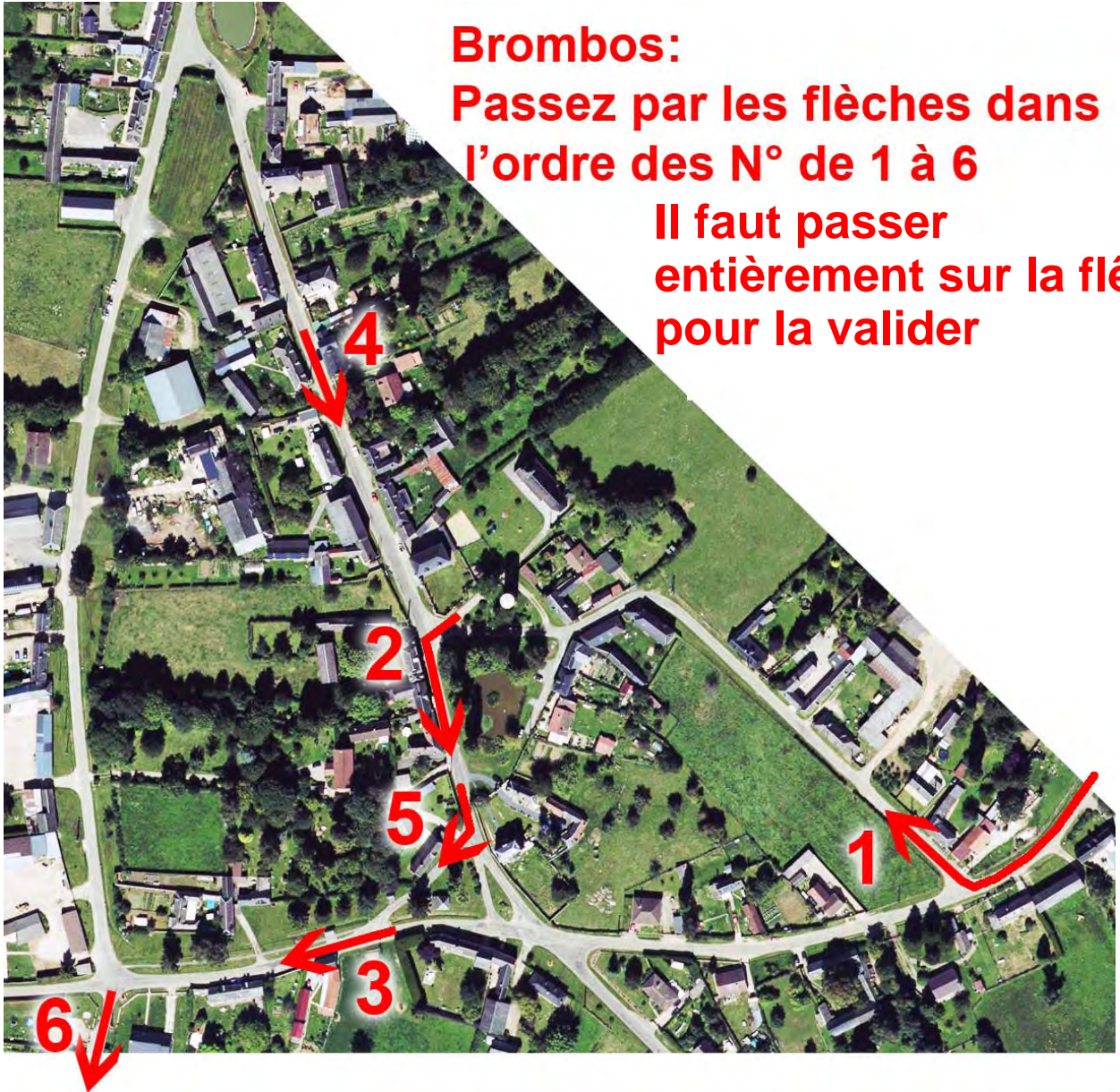



Brombos:
 Passez par les flèches dans
 l'ordre des N° de 1 à 6
 Il faut passer
 entièrement sur la flèche
 pour la valider

13		Brombos
8,79		
14		C3 Hautbos
1,10		
9,89		
15		Hautbos RDA
10,34		

16		
11,24		
17		
18		RSRP
13,60		

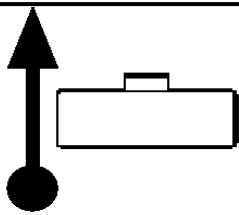
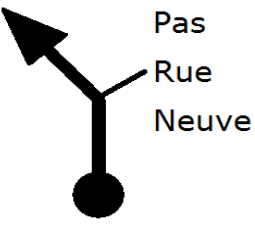
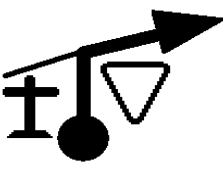
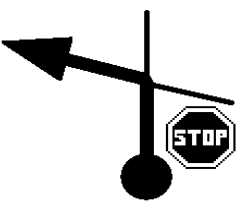
10èmes Routes du Vexin Classic

N° Partiel Total	Indication	Commentaire
19		St Deniscourt RSRP
20		Pas Rue Neuve et RDA
14,45		
21		D119
16,74		
22		D150 Crillon

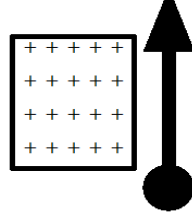
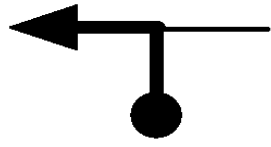
N° Partiel Total	Indication	Commentaire
23		
24		
17,59		
25		
18,12		
26	Suivre carte page suivante	

N° Partiel Total	Indication	Commentaire	N° Partiel Total	Indication	Commentaire
---------------------	------------	-------------	---------------------	------------	-------------

26





vous êtes ici → **1** - Empruntez les flèches de 1 à 6 en prenant le chemin le plus court par toutes les voies représentées sur la carte y compris chemins

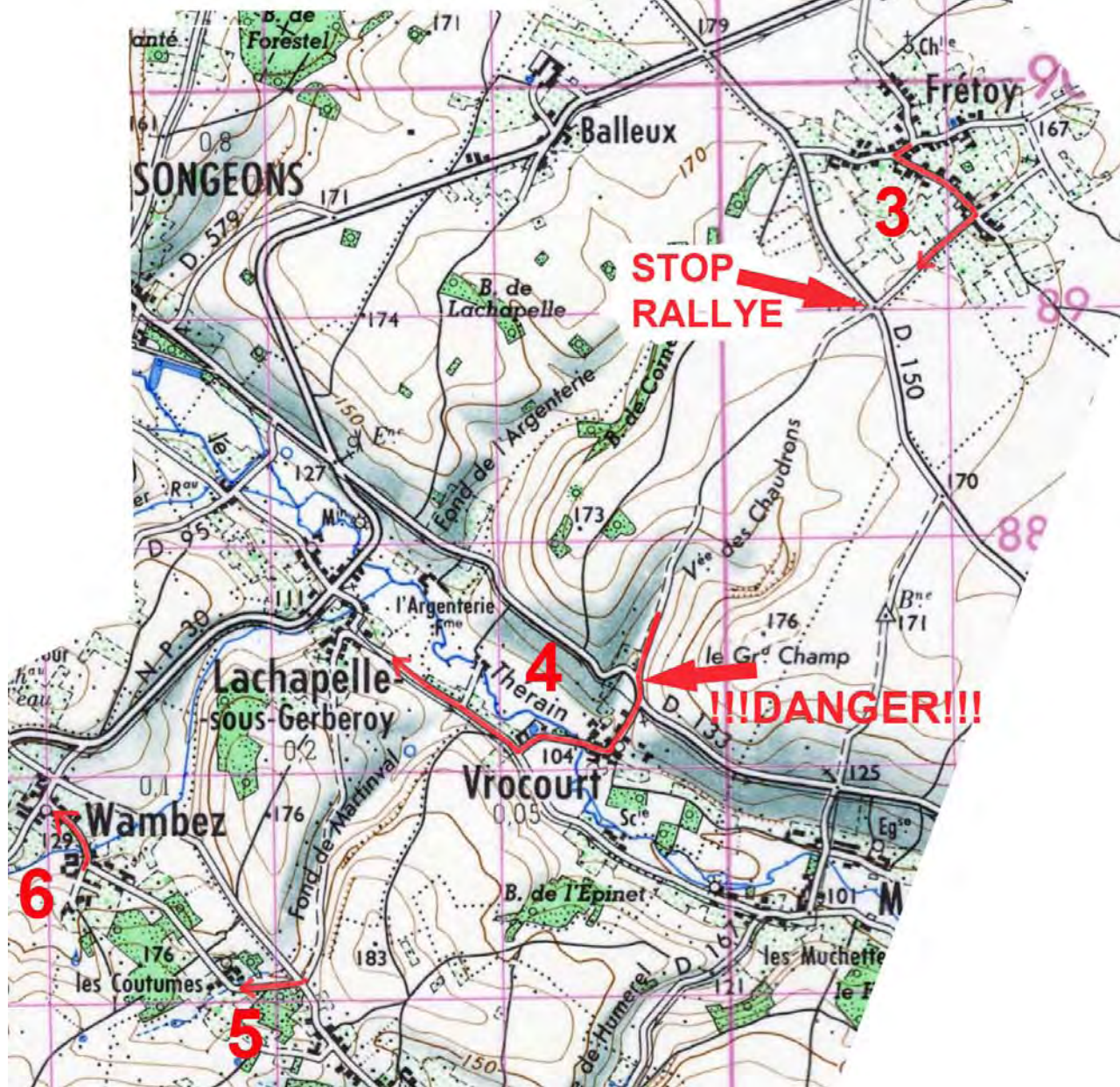

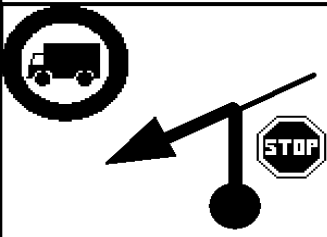
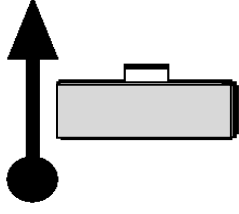

C'est une vieille carte les chemins sur la carte ont été presque tous bitumés



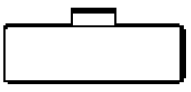

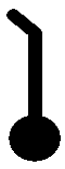
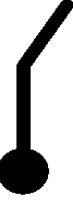
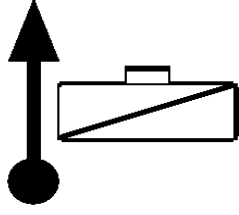
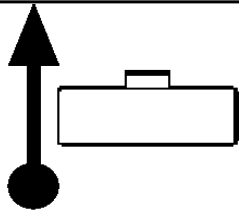
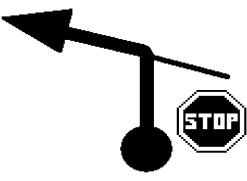
10èmes Routes du Vexin Classic



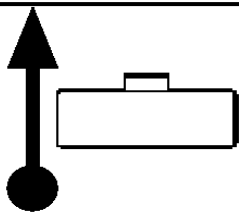
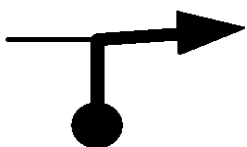
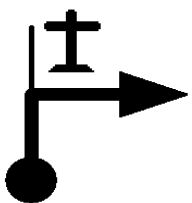
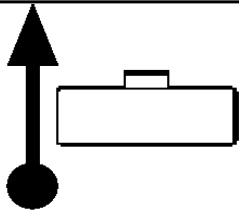
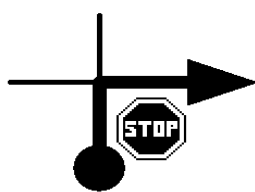
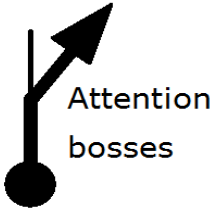

N° Partiel Total	Indication	Commentaire
27		
30,71		
28		(Wambez)
0,48		
31,19		
	<div style="border: 1px solid black; padding: 5px; margin-bottom: 5px;">Route dégradée sur 1.5km</div> <div style="border: 1px solid black; padding: 5px;">Ensuite seule la route par où vous arrivez et celle à ne pas prendre sont indiquées</div>	
29		
33,77		
30		
31		
32		
33		Bois Aubert D167
34,49		

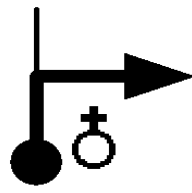
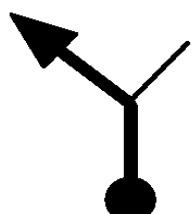
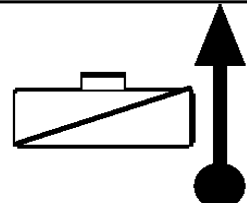
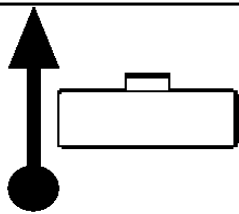
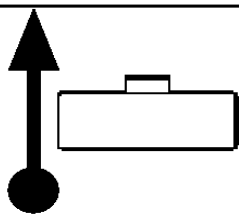
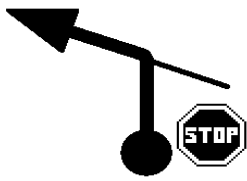

N° Partiel Total	Indication	Commentaire
34		
35		et RDA
0,03		
36		Bois Aubert D167
35,23		
37	Pas Epluques	
36,31		
38		Senantes
39		D1
40	Quitter D1	et RDA
36,83		
41		Le Bray

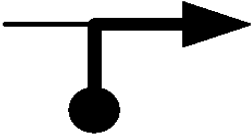
10èmes Routes du Vexin Classic

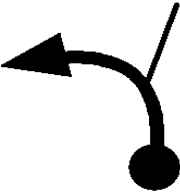
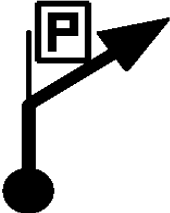
N° Partiel Total	Indication	Commentaire
42		Goulancourt
43	A G	et RDA
38,76		
44		
45		et RDA
46		Senantes
47		
41,17		
48		interdit aux tracteurs sauf riverains
41,35		
49	A G	
42,56		

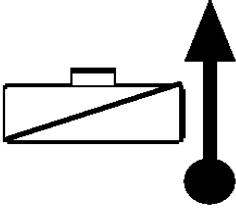
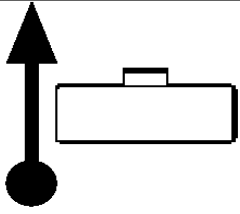
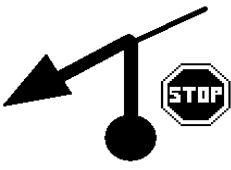
N° Partiel Total	Indication	Commentaire
50		
43,41		
51		
45,42		
52		et RDA
45,57		
53		Route de la Haute rue
45,97		
54		Blacourt D502 RSRP
46,14		
55		la Haute Rue RDA
47,08		
56		Lachapelle-aux-Pots RSRP
49,29		
57		Suivre D501
49,85		

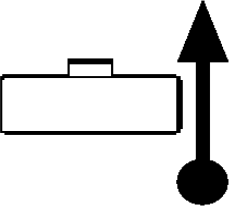
N° Partiel Total	Indication	Commentaire
58		D501 Savignies
50,07		
59		
50,10		
60		D501
50,29		
61		rue des tilleuls Tout au bout vous passerez devant la maison du regretté Francis Cuisin, pilote puis speaker
50,60		
62		
63		Lachapelle-aux-Pots RDA
51,44		
64		Héricourt
65		Armentières
52,56		

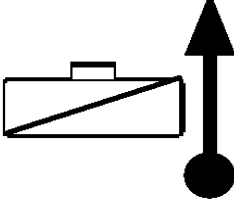
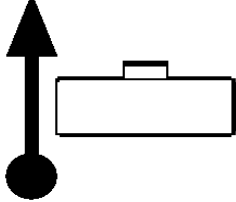
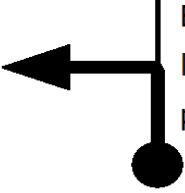
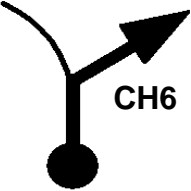
N° Partiel Total	Indication	Commentaire
66		Armentières
52,72		
67		RSRP D501
53,15		
68		Armentières
1,28		
69		Savignies
56,75		
70	A D	D1 Beauvais et RDA
57,38		
71	 Bar de la piscine	RSRP
57,72		
72	 CH6	Avance autorisée
58,20		