

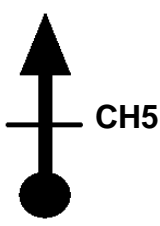

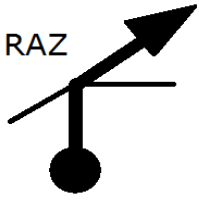

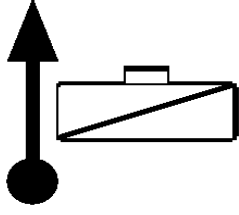
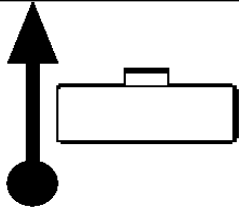
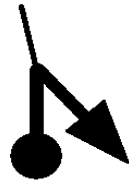

10èmes Routes du Vexin Classic

N° Partiel Total	Indication	Commentaire
1 0,00		
2 0,13		RAZ Sarnois
3 0,68		
4 1,09		Grandvilliers
5 1,51		D315 A29
6 1,71		
7 1,97		
8 2,29		

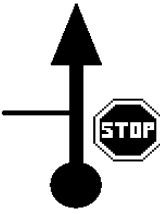

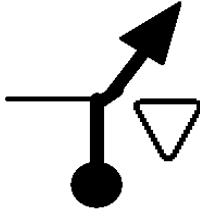
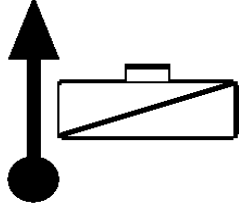
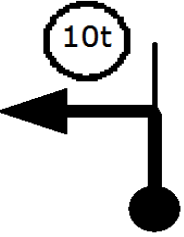
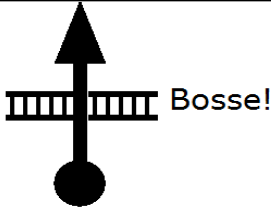
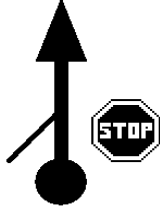
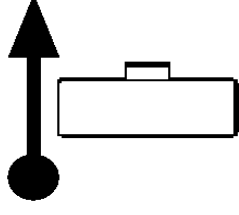

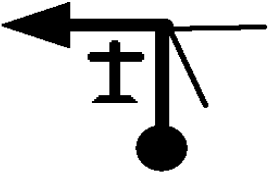



N° Partiel Total	Indication	Commentaire
9 2,44		RSRP
10 3,49		Grandvilliers D124
11 5,36		Brombos
12 5,81		
13 6,80		
14 7,02		Brombos D96
15 7,15		
16 7,42		

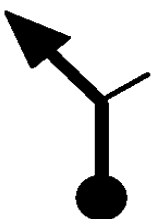

10èmes Routes du Vexin Classic

N° Partiel Total	Indication	Commentaire
17 0,09 7,51		
18 0,04 7,55		
19 0,17 7,72		
20 0,40 8,12		
21 0,27 8,39		
22 0,09 8,48		
23 0,06 8,54		
24 0,11 8,65		Rue de Hautbos

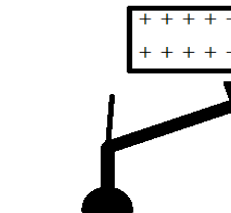
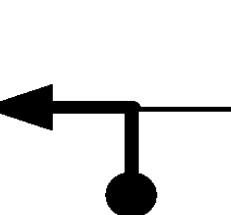

N° Partiel Total	Indication	Commentaire
25 0,12 8,77		Brombos
26 1,09 9,86		Danger D7 C3 Hautbos
27 0,46 10,32		Hautbos
28 0,51 10,83		St Deniscourt
29 0,39 11,22		
30 0,57 11,79		
31 1,79 13,58		RSRP
32 0,38 13,96		St Deniscourt RSRP

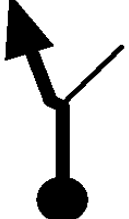

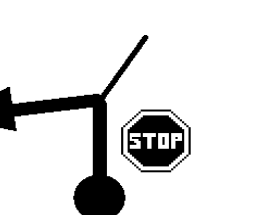
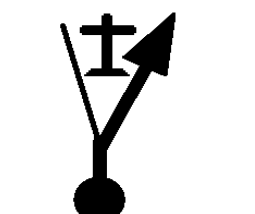
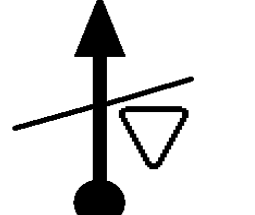
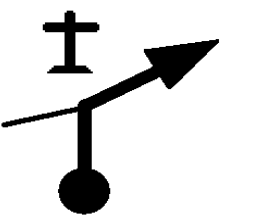
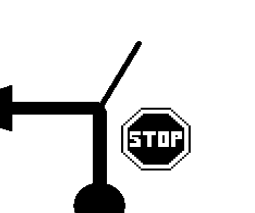
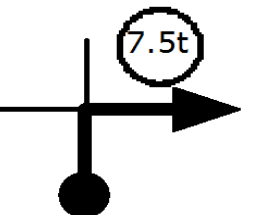
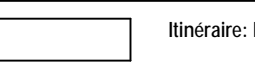



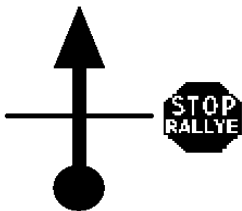
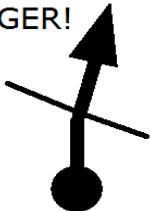
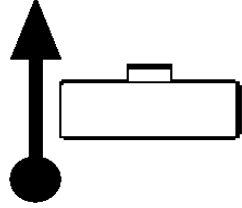
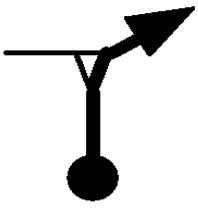
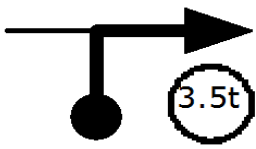
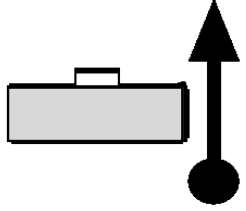
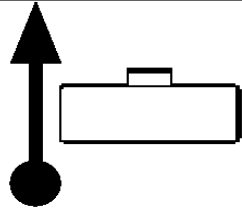

10èmes Routes du Vexin Classic

N° Partiel Total	Indication	Commentaire
33 0,47	 Pas Rue Neuve	et RDA
14,43		
34 0,13		
14,56		
35 0,21		
14,77		D119
36 1,95		D150 Crillon
16,72		
37 0,51		
17,23		
38 0,06		
17,29		
39 0,23		
17,52		
40 0,53		
18,05		

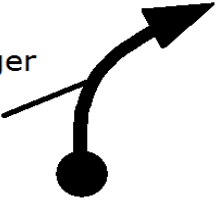

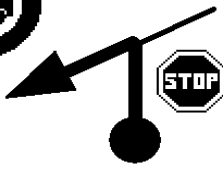
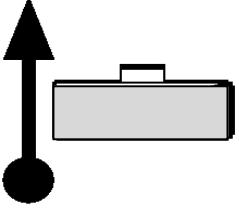

N° Partiel Total	Indication	Commentaire
41 0,07		C Grémévillers
18,12		
42 1,87		
19,99		
43 0,17		
20,16		
44 0,63		
20,79		
45 0,20		C1 Fretoy
20,99		
46 0,79		
21,78		
47 0,10		
21,88		
48 0,45		
22,33		



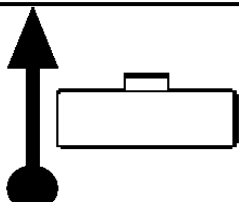
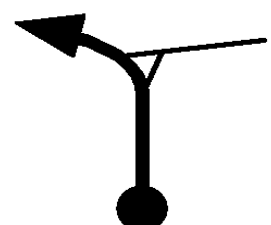
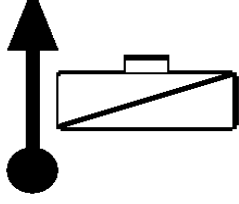
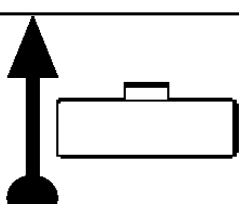

10èmes Routes du Vexin Classic

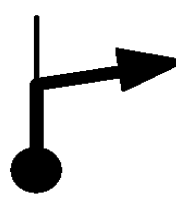
N° Partiel Total	Indication	Commentaire
49 0,60 22,93		
50 2,11 25,04	DANGER! 	C2 Vrocourt
51 0,05 25,09		Vrocourt
52 0,19 25,28		
53 0,47 25,75		
54 0,32 26,07		
55 0,39 26,46		La Chapelle s/Gerberoy
56 0,13 26,59		Rue de martinval

N° Partiel Total	Indication	Commentaire
57 1,71 28,30		Wambez les coutimes
58 0,50 28,80		
59 0,67 29,47	Danger 	
60 0,35 29,82	 	
61 0,48 30,30		(Wambez)
62 2,46 32,76		
63 0,12 32,88		
64 0,11 32,99		

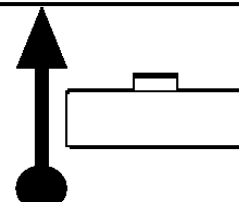
10èmes Routes du Vexin Classic

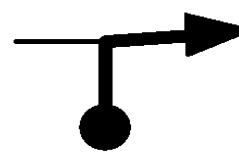
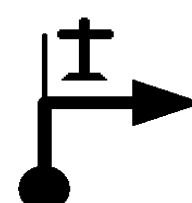
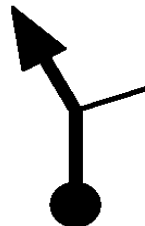
N° Partiel Total	Indication	Commentaire
65 0,54		Bois Aubert D167
33,53		
66 0,18		
33,71		
67 0,54		Bois Aubert D167
34,25		
68 1,07	Pas Epluques	
35,32		
69 0,09		Senantes
35,41		
70 0,25		D1
35,66		
71 0,03		
35,69		
72 0,42		Le Bray
36,11		

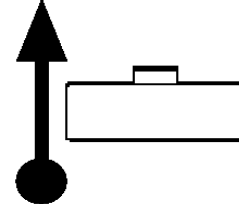
N° Partiel Total	Indication	Commentaire
73 0,70		Goulancourt
36,81		
74 0,28		
37,09		
75 0,49		(rue Fontaine Lambert)
37,58		
76 0,75	miroir 	
38,33		
77 0,28		
38,61		
78 0,17		
38,78		
79 0,28		
39,06		
80 0,52		Senantes
39,58		

10èmes Routes du Vexin Classic

N° Partiel Total	Indication	Commentaire
81 0,41		
39,99		
82 0,18		interdit aux tracteurs sauf riverains
40,17		
83 1,21		
41,38		
84 0,85		
42,23		
85 2,01		
44,24		
86 0,14		
44,38		
87 0,39		Route de la Haute rue
44,77		
88 0,18		Blacourt D502 RSRP
44,95		

N° Partiel Total	Indication	Commentaire
89 0,94		la Haute Rue
45,89		
90 0,21		
46,10		
91 0,76		
46,86		
92 0,46		
47,32		
93 1,02		Lachapelle-aux-Pots RSRP
48,34		
94 0,56		Suivre D501
48,90		
95 0,22		D501 Savignies
49,12		
96 0,03		
49,15		

N° Partiel Total	Indication	Commentaire
97 0,19 49,34		D501
98 0,31 49,65		rue des tilleuls Tout au bout vous passerez devant la maison du regretté Francis Cuisin, pilote puis speaker
99 0,40 50,05		
100 0,44 50,49		Lachapelle-aux-Pots
101 0,50 50,99		C8 Héricourt
102 0,59 51,58		Héricourt
103 0,03 51,61		Armentières
104 0,16 51,77		Armentières

N° Partiel Total	Indication	Commentaire
105 0,43 52,20		RSRP D501
106 0,29 52,49		
107 0,69 53,18		
108 0,29 53,47		Armentières
109 2,33 55,80		Savignies
110 0,58 56,38		Beauvais
111 0,33 56,71		RSRP
112 0,48 57,19		Avance autorisée